

# Accento 8 RGBW

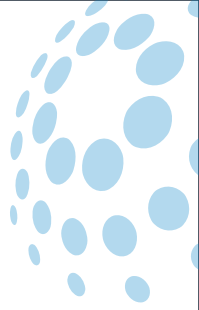

LED ACCENT LIGHT

ILLUMINATE YOUR WORLD

## Specification Code

Example showing how to specify a Accento 10 luminaire.

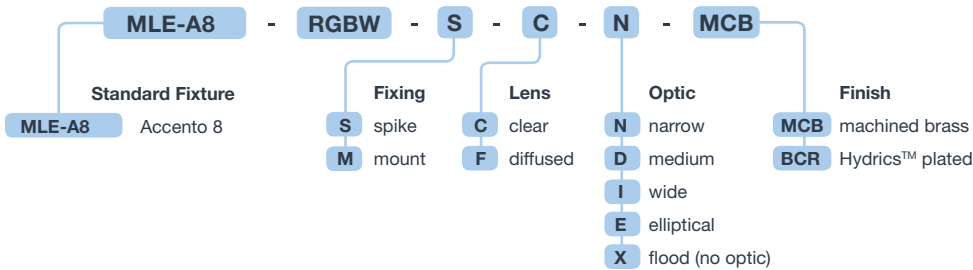

## Specifications

IP rating	Ingress Protection - IP67
Materials & finish	thermally optimised DZR brass optional Hydrics™ plated finish
Lens	clear or diffused 5mm tempered glass
Light source	CREE™ MC-E quad chip RGBW LED
CRI	variable depending on colour mix
Performance	> 70% lumen maintenance at 50,000 hours
Optic (FWHM)	narrow 19°, medium 26°, wide 35°, elliptical 45° x 15° flood > 100° ( no optic ) offers the widest distribution
Efficacy	up to 100 lumens per watt
Power	8 watts total
Control	DMX 512 or DALI ( using the DALI to DMX bridge )
Power supply	<b>Optimo QUAD™</b> MLE-OM-DMX4
	4 Channels / 1 Group
	12 luminaires

All dimensions shown are in millimetres ( mm )



FINISH OPTIONS

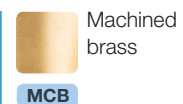

## Accessories

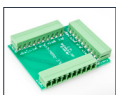

MEGABAY PCB LINK BOARD  
MLE-RGBW-LK



MEGABAY 10 CORE CABLE  
MLE-RGBW-?M

MOUNT FIXING **M**

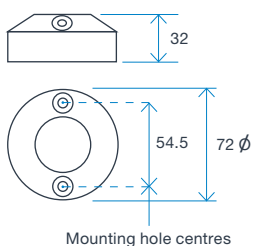

Mounting hole centres

SPIKE FIXING **S**

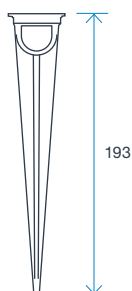

EXTENSION POST

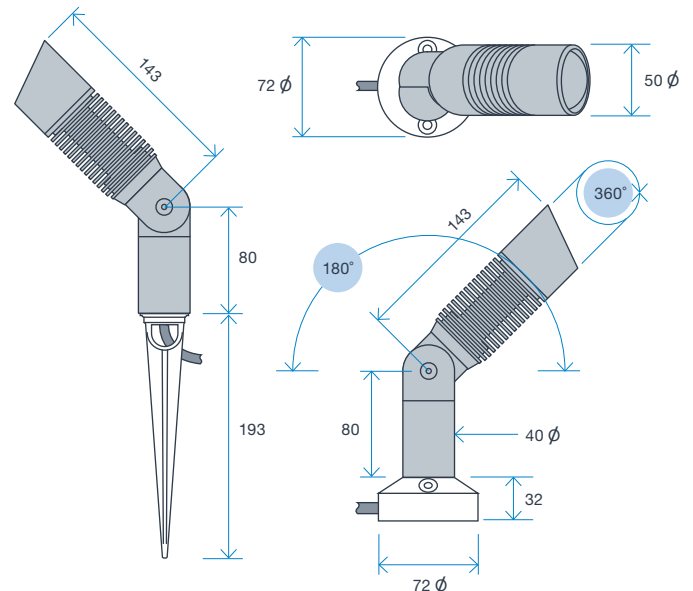
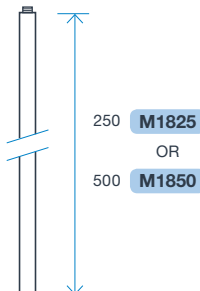

Spike fixing

Mount fixing



For the latest information visit - [www.megabay.com/accento](http://www.megabay.com/accento)

Specifications are subject to change without notice. CREE™ is a registered trademark of CREE Inc.

MLE-A10-RGBW

Rev 02